

Varenummer: 03446180  
Beskrivelse: Fluro Heavy Duty Ledleje GE 180 GW-2RS  
Hul Ø180  
Note: 180

## Mål

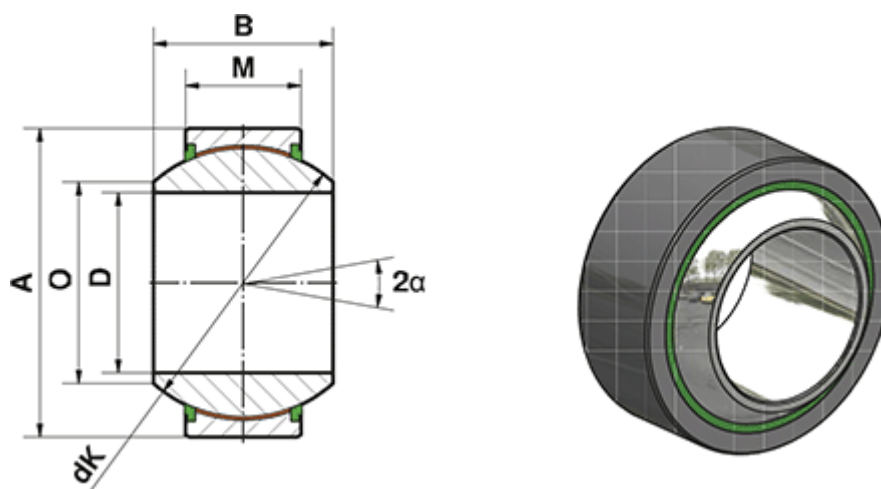

= -	Dynamisk belastning C (kN) = 6000
= -	M = 100
= -	O = 196.1
A = 290	Statisk belastning C0 (kN) = 10000
a (grader) = 14	Vægt (g) = 33600
B = 155	
D = 180	
dK = 250	